

Front View

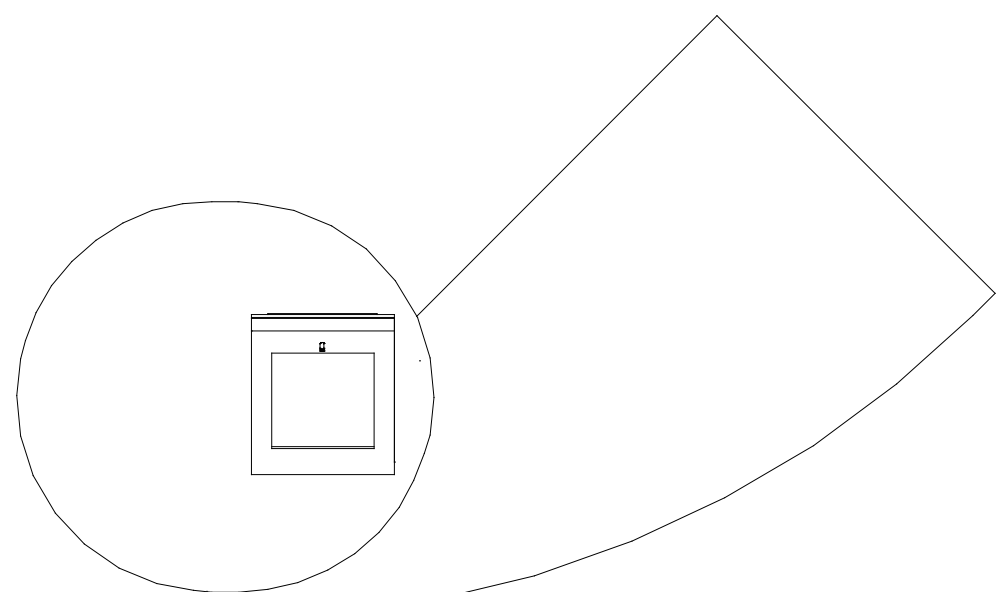

Plan View

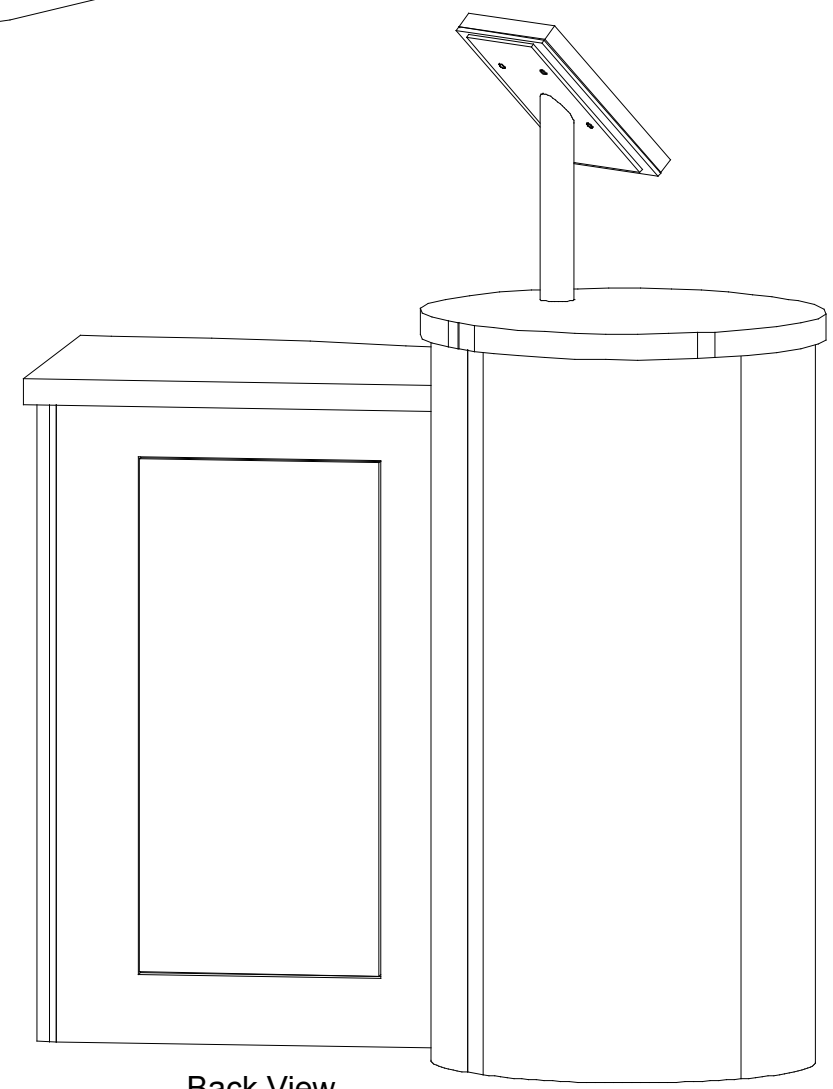

Back View

# euro lt | HYBRIDS

## Euro LT Hybrids General Setup Instructions

### Using Your Setup Instructions

The Euro LT Hybrid Setup Instructions are created specifically for your configuration. They are laid out sequentially in levels, including exploded views, and a logical series of detailed steps to assemble the main structure and components. We encourage you to study the instructions **before** attempting to assemble your exhibit.

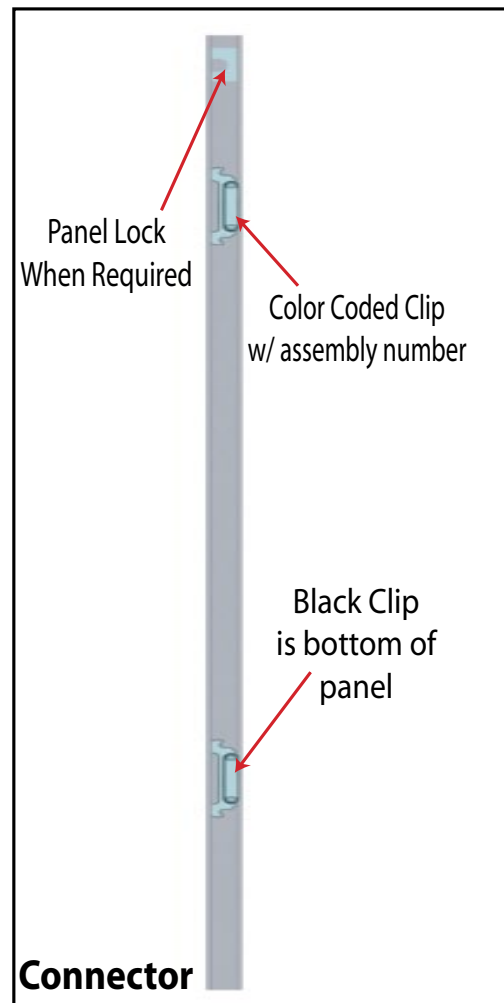

Each component has 2 clips, the lower clip is ALWAYS black.

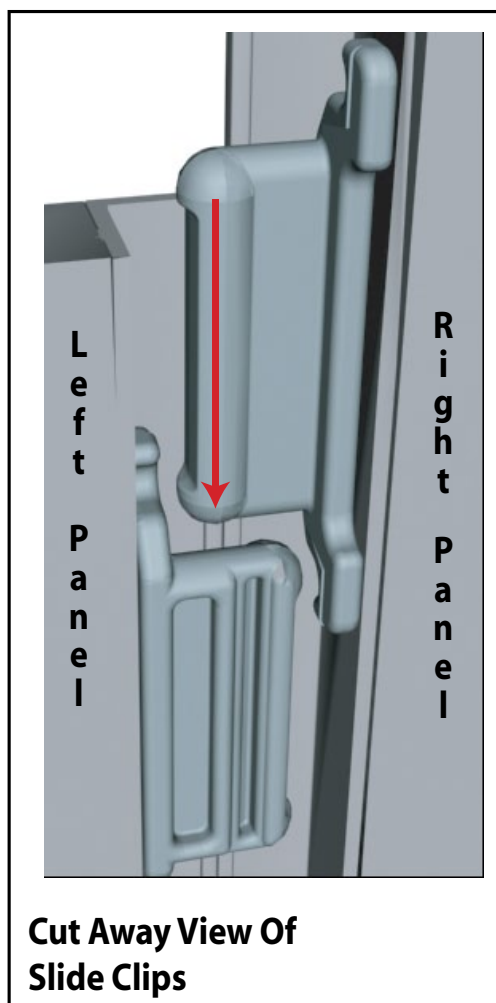

Components connect together by aligning them and sliding downward connecting clips together.

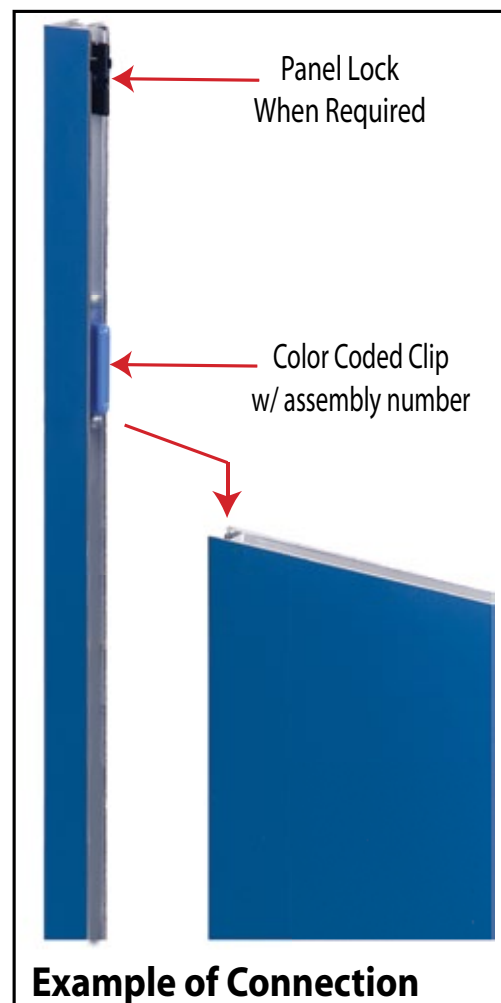

Configurations are assembled from left to right, usually starting with #1 and following the numbered sequence.

### Cleaning and Packing Your Display

- 1) When cleaning laminate countertops or panels use mild cleansers and a soft material such as cotton.
- 2) Keep all display components away from extreme heat and long exposure to sunlight to avoid warping and fading.
- 3) Retain all packing material. It will make re-packing much easier and will reduce the likelihood of shipping damage.

The top clip is color coded to distinguish the level. The color coded clip also contains the numbered label.

Level 1 =	Blue
Level 2 =	Red
Level 3 =	Green
Level 4 =	Black

**Color Code**

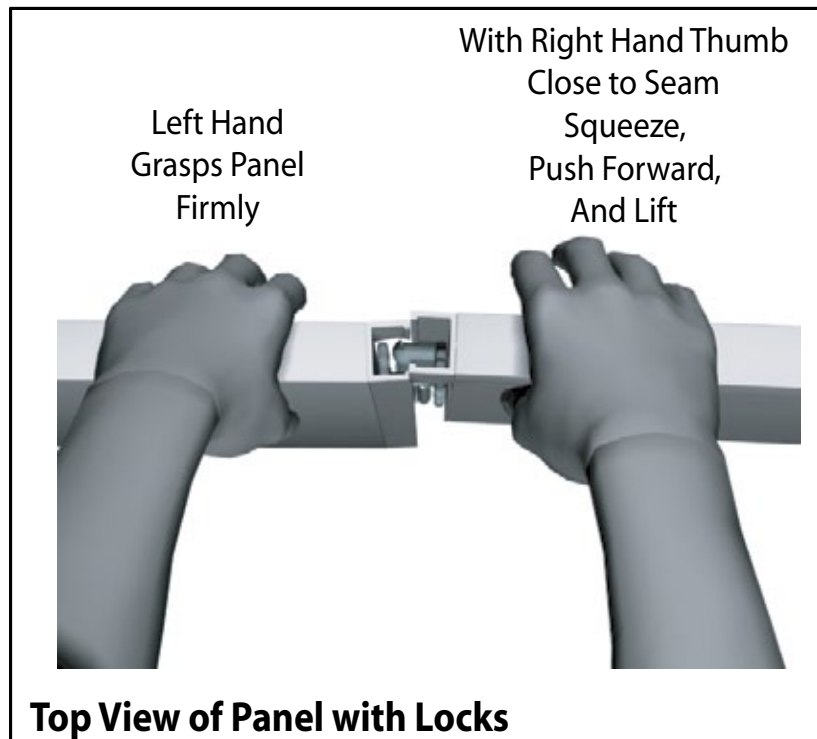

The first level of components contains panel locks that are located at the top of the panel for extra stability and a seamless connection. When disassembling panels, twist top connection slightly and lift right panel upward.

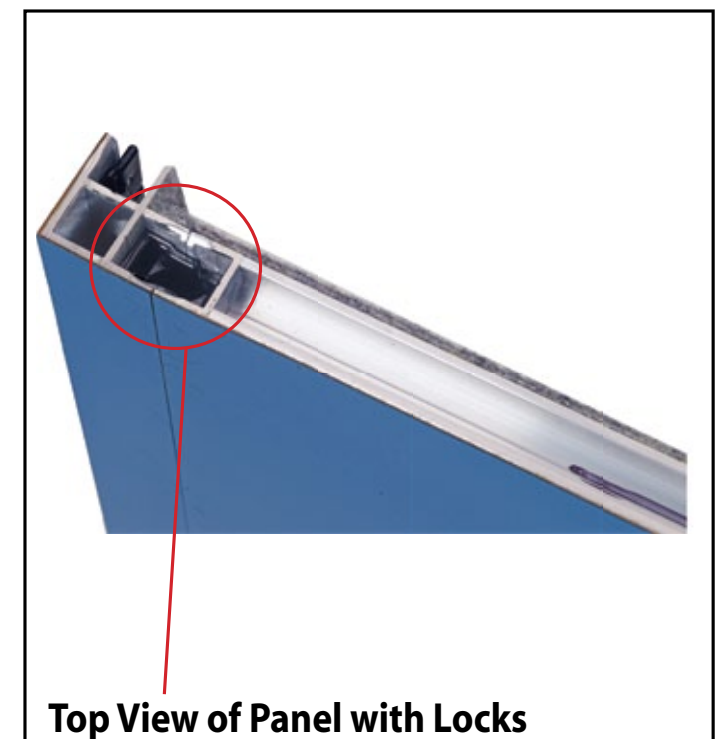

Item	Qty.	Description
1	1	42”h Vertical LT T-Connector
2	1	42”h x 9.5”w Curved LT-Panel
3	1	42”h x 9.5”w Curved LT-Panel
4	1	42”h Vertical Extrusion LT Connector
5	1	42”h x 9.5”w Curved LT-Panel
6	1	42”h x 9.5”w Curved LT-Panel
7	1	38”h x 57.5”w Curved LT-Panel
8	1	38”h x 57.5”w Curved LT-Panel
9	1	38”h 90 degree LT Corner Connector
10	1	38”h x 19”w LT-Panel
11	1	38”h 90 degree LT Corner Connector
12	1	38”h x 23.624”w Assembled LT Door Panel
13	1	38”h 90 degree LT Corner Connector

- Steps:
- 1) Connect pieces [1,2,3,4,5,6] together in numerical order.
  - 2) Attach panel [7] to assembled [1/2/3/4/5/6].
  - 3) Connect pieces [8,9,10,11,12] together in numerical order.
  - 4) Insert Interior shelf.
  - 4) Attach vertical extrusion 13 to top of round counter top.
  - See Ipad Stand Attachment detail.
  - 5) Place Counters on top of assembled kiosk body.
  - 6) Attach iPad Swivel Mount. See [Swivel iPad Clamshell Attachment](#) detail.
  - 7) Connect iPad Clamshell to Swival Mount.

